

PELLET BOILER STOVE – AMANDA Diva 16,1 kW



AMANDA

diva

16,1kW

Carefully read all the instructions before the installation and use of the stove.
This manual is an important part of the product.

Address

Gekas Metal Group - Gkekas Savvas & Yios OE Co
Phone: +030 2310 538 103 | FAX: +030 2310 723 879
17o hlm Thess/nikis - Veroias
57003 Agios Athanasios, Thessaloniki, Greece
info@gekasmetal.gr
www.gekasmetal.gr

PELLET BOILER STOVE – AMANDA Diva 16,1 kW

Dear customer,

Thank you for placing your confidence in our company and congratulations for your choice!

*You are now the owner of a pellet boiler stove designed and manufactured by the Greek company **Gekas Metal Group**.*

Your new pellet stove is an ideal heating solution. It uses advanced technology and it has been constructed according to high quality standards, with modern design and safety functions that allow you to enjoy its warmth with absolute safety while also decorating your rooms.

CONTENTS

- 1: Introduction 4
 - 1.1: Intended use 4
 - 1.2: Intended users 4
 - 1.3: Manufacturer’s liability..... 4
 - 1.4: Main reference standards 4
 - 1.5: Technical service..... 4
 - 1.6: Spare parts..... 4
 - 1.7: Identification label..... 5
 - 1.8: Delivery, handling and packaging 5
 - 1.9: Technical specifications 5
 - 1.10: Electrical connection..... 5
- 2: Important information..... 6
 - 2.1: General information 6
 - 2.2: General warning and safety information..... 6
 - 2.3: First heating 7
 - 2.4: Safety distances 7
 - 2.5: Before set up..... 7
 - 2.6: The correct chimney connection 8
- 3: Brief information on pellets..... 9
 - 3.1: What are pellets?..... 9
 - 3.2: Wood pellet specification according to ENplus – A1..... 9
 - 3.3: Pellet hopper refilling during operation 9
 - 3.4: Pellet storage 9
- 4: Technology & safety functions 10
 - 4.1: Operating comfort 10
 - 4.2: High efficiency – low emissions 10
 - 4.3: Pressure in the combustion chamber..... 10
 - 4.4: Emergency Pressure Relief Valve..... 10
 - 4.5: Low-temperature shutdown..... 10
 - 4.6: Electrical excess current protection 10
 - 4.7: Auto Clean 10
 - 4.8: Easy Clean 11
 - 4.9: Ash Trap 11
 - 4.10: Component monitoring 11
 - 4.11: Feeder motor monitoring 11
 - 4.12: Power failure (during operation)..... 11
 - 4.13: Power failure (during ignition)..... 11



PELLET BOILER STOVE – AMANDA Diva 16,1 kW

5: Installing the stove.....	11
5.1: General information	11
5.2: Safety precautions	11
5.3: Connection to the chimney	12
5.4: Connecting to a steel chimney	12
5.5: Stove installation site.....	13
5.6: Feeding in external combustion air	13
5.7: Flue gas exhaust.....	13
5.8: Discharged through roof using a traditional chimney.....	13
5.9: Levelling the stove	14
5.10: System connections.....	14
5.11: Post-installation work	15
6: Control panel	17
6.1: Description.....	17
6.2: Using the control panel.....	18
6.3: Status leds.....	18
6.4: Control panel menus	19
7: Preliminary control panel operations	20
7.1: Loading the pellets.....	20
8: Initial settings.....	20
8.1: Time and date settings	20
8.2: Setting the display brightness.....	20
8.3: Setting the beeper volume	21
8.4: Improving the combustion	21
9: Stove operation	22
9.1: Operating parameters	22
9.2: Switching the stove on.....	22
9.3: Modifying the parameters (See 8.4: Improving the combustion).....	23
9.4: Switching the stove off	23
9.5: Operating by monitoring room temperature	23
9.6: Restarting after a power failure	23
10: Weekly Schedule.....	24
10.1: Weekly Timer	24
10.2: Setting the weekly timer programs	24
10.3: Assigning the weekly timer programs to specific days.....	24
10.4: Enabling/disabling the weekly timer	24
11: Miscellaneous settings.....	25
11.1: Enabling Key Lock function	25
11.2: Changing the temperature units	25
12: Alarm management	26
13: Cleaning and maintenance	27
13.1: Inspection and maintenance plan	27
14: Problems – possible solutions	28
14.1: Problem 1.....	28
14.2: Problem 2.....	28
14.3: Problem 3.....	28
15: Warranty.....	29
16: Installation Protocol.....	30
17: Decommissioning and disposal.....	31
18: Product fiche.....	32

PELLET BOILER STOVE – AMANDA Diva 16,1 kW

1: INTRODUCTION

1.1: INTENDED USE

The product is a domestic heating stove, powered exclusively with wood pellets, with automatic operation. The stove can only operate when the combustion chamber door is closed.

Warning

Never open the door when the stove is operating.

Note

The intended use of the stove described above and the configurations available are the only ones permitted by the manufacturer: never use the stove in any way not described by the instructions provided.

1.2: INTENDED USERS

The user of the stove must be a responsible adult with enough technical knowledge to carry out routine maintenance on the parts of the stove.

Note

The appliance is not intended for use by people (including children) with limited physical, sensorial or mental abilities, or without sufficient experience or knowledge, unless they are supervised or instructed on the use of the appliance by a person responsible for their safety.

Note

Make sure children do not play close to the stove while it's operating.

1.3: MANUFACTURER'S LIABILITY

By providing this manual, Gekas Metal Group declines all liability, both civil and criminal, direct or indirect, deriving from:

- Installation not in compliance with the standards in force in the country concerned and with safety directives.
- Partial or total failure to follow the instructions provided in this manual.
- Installation by unqualified and untrained personnel.
- Use not in compliance with safety directives.
- Modifications and repairs on the stove that are not authorized by the manufacturer.
- Use of spare parts that are not original or not specific for the model of the stove.
- Lack of maintenance.
- Exceptional events.

1.4: MAIN REFERENCE STANDARDS

- **EN ISO 9001/2015:** "Certificate of quality management system"
- **EN ISO 14001/2015:** "Certificate of environmental health and safety management system"
- **BS OHSAS 18001/2007:** "Certificate of occupational health and safety management system"
- **Directive 2014/35/UE:** "Electrical equipment designed for use within certain voltage limits".
- **Directive 2014/30/UE:** "Approximation of the laws of the Member States relating to electromagnetic compatibility".
- **Directive 89/391/EEC:** "Introduction of measures to encourage improvements in the safety and health of workers at work".
- **EU Regulation 305/2011:** "sets harmonized requirements for the sale of construction products in abrogation of Directive 89/106/EEC".
- **Directive 85/374/EOK:** "Approximation of the laws, regulations and administrative provisions of the Member States concerning liability for defective products."
- **Directive 1999/5/EC:** "Radio equipment and telecommunications terminal equipment and the mutual recognition of their conformity".
- **EN 14785/2006:** "Residential space heating appliances fired by wood pellets - Requirements and test methods".
- **EN 10204/2004:** "Certificate of steel inspection".
- **EN ISO 15614-01:** "Specification and qualification of welding procedures for metallic materials".
- Failure to follow the instructions provided in this manual will render the warranty void.

1.5: TECHNICAL SERVICE

Gekas Metal Group has an extensive network of service centers staffed by specialists trained directly by the company.

Please contact our head office or sales network for details of your nearest authorised service center.

1.6: SPARE PARTS

Only use original spare parts and replace worn components before they malfunction. Doing so helps prevent accidents due to sudden breakages, which may cause serious harm to people and other belongings. Perform the periodical maintenance checks as described in the chapter "Cleaning and Maintenance" (see 13 Cleaning and maintenance).

PELLET BOILER STOVE – AMANDA Diva 16,1 kW

1.7: IDENTIFICATION LABEL

The serial number plate on the stove shows all the typical product data, including the manufacturer's details, the serial number and CE markings.

1.8: DELIVERY, HANDLING AND PACKAGING

Your first impression is important to us!

The packaging of your new stove provides excellent protection against damage. However, damage to the stove and accessories may still occur during transport.

Note

Therefore please check your stove on receipt for damage and completeness! Report any deficiencies to your dealer immediately! Pay particular attention during unpacking. Scratches to the material can easily occur.

The following material is provided inside the stove:

- Instruction manuals
- Remote control
- Levelling feet

Warning

Prevent children from playing with the packaging components (e.g. film and polystyrene). Danger of suffocation.

The stove is delivered packaged in a cardboard box and secured to a wooden pallet for handling by forklift and/or other equipment.

The stove is delivered complete with all parts included.

Beware of the tendency of the stove to tip over. The stove's center of gravity is towards the front of the appliance. Always keep this in mind when moving the stove on the transport pallet. When lifting avoid jolts or sudden movements.

Make sure that the forklift capacity exceeds the weight of the stove being lifted. The operator of the forklift or hoisting equipment is responsible for lifting the loads.

To remove the stove from the transport pallet, use appropriate equipment.

1.9: TECHNICAL SPECIFICATIONS

Model	AMANDA Diva
Dimensions (HxLxW)	1070x612x560 mm
Voltage	230 V
Nominal power	8,4kW – 16,1kW
Maximum efficiency	92,6%
Weight	175 kg
Pellet hopper capacity	32 L
Estimated heating space	410 m ³
Content of CO in the smoke (normalised to 13% O ₂)	283,75 – 183,75 mg/Nm ³
Flue gas temperature	153,4°C
Minimum consumption	1,89 – 1,91 kg/h
Maximum consumption	3,7 - 3,71 kg/h

Note

Please observe the national and European standards as well as local regulations concerning the installation and operation of firing installations!

1.10: ELECTRICAL CONNECTION

The stove is supplied with an approx. 1,5m long connecting cable with a Euro-plug. This cable is to be connected to a 230Volt/50Hz socket. The average electrical power consumption is some 0,11kW/h in heating operation. And approx. 0,36kW/h during automatic ignition. The connection cable must be laid so that there is no contact to any sharp edges or hot surfaces of the stove.

PELLET BOILER STOVE – AMANDA Diva 16,1 kW

2: IMPORTANT INFORMATION

2.1: GENERAL INFORMATION

Requesting information

If information is requested from the manufacturer of the stove, always refer to the serial number and other identifying data shown on the product's identification label.

Responsibility for installation

Gekas Metal Group accepts no responsibility for the work carried out to install the stove, such responsibility lies with the installer, who is required to carry out checks on the flue and air intake and ensure installation is completed correctly. Furthermore, all safety standards required by relevant legislation in force in the country where the stove is installed must be complied with.

Use

The stove must only be used in compliance with the instructions provided in this manual, as well as with all safety standards required by relevant legislation in force in the country where the stove is installed.

2.2: GENERAL WARNING AND SAFETY INFORMATION

Observance of the introductory general warning information is imperative.

- Read the entire manual thoroughly before installing and putting the stove into service. Observe the national provisions and laws as well as the regulations and rules applicable locally.
- Gekas Stoves should only be installed in rooms with normal humidity.
- Only approved transport equipment with enough load carrying capacity may be used with your heating appliance.
- Your heating appliance is not suitable for use as a ladder or stationary scaffolding.
- The burning of fuel releases heat energy that lead to extensive heating of the stove surfaces, doors, door and operating handles, glass, flue pipes and possibly the front wall and side walls. Refrain from touching these parts without appropriate protective clothing or equipment e.g. heat-resistant gloves or means of operation.
- Make your children aware of this danger and keep them away from the stove during heating.
- Only burn approved heating materials.
- The combustion or introduction of highly flammable or explosive materials such as empty spray cans etc. in the combustion chamber and storing them near

the stove is strictly prohibited due to the danger of explosion.

- Use heat-resistant gloves to open the door of your stove.
- Make sure that no embers fall out of the combustion chamber onto inflammable material.
- Placing non-heat resistant objects on the stove or near it is prohibited.
- Do not place clothing on the stove to dry.
- Laundry racks etc. must be placed at enough distance to the stove – ACUTE DANGER OF FIRE!
- When your stove is burning, the use of highly inflammable and explosive materials in the same or adjacent rooms is prohibited.
- If the stove is heated in continuous operation, the cleaning intervals are shorter. Increased wear, especially of the thermally stressed parts, is the result. Please therefore strictly follow the requirements for cleaning and maintenance!

Warning

Waste and liquids may not be burnt in the stove!

Note

To prevent your stove's internal components from overheating, do never cover the convection fins.

Note

CAUTION when filling the pellet hopper. The opening of the pellet hopper is sufficiently dimensioned to ensure easy filling. Take great care that no pellets drop to the convection fins and the hot stove body. This can cause a lot of smoke.

Tip

We recommend refilling the pellet hopper when the stove is inactive and still cold.

Note

Your stove will expand and contract during the heating and cooling phase, respectively, which can sometimes lead to slight bending or cracking noises. This is normal and there is no reason to worry or complain.

PELLET BOILER STOVE – AMANDA Diva 16,1 kW

2.3: FIRST HEATING

The stove body, just as various steel parts, cast iron parts and the flue pipes are painted with a heat resistant paint. During the first heating of the stove the paint dries out completely. This may cause a slight smell so it is recommended that the room should be well ventilated when starting the stove for the first few times. Touching or cleaning the painted surfaces during the curing should be avoided at all costs. It is recommended to operate the stove at high power once or twice after the first heating for the paint to finish hardening.

After the first heating, the glass rope (door gasket) is expected to be displaced due to the liquification of the paint. This is expected. All you must do is place the rope back to its' place. This is expected to also happen for the burning pot rope (burn pot gasket) during its first cleaning.

2.4: SAFETY DISTANCES

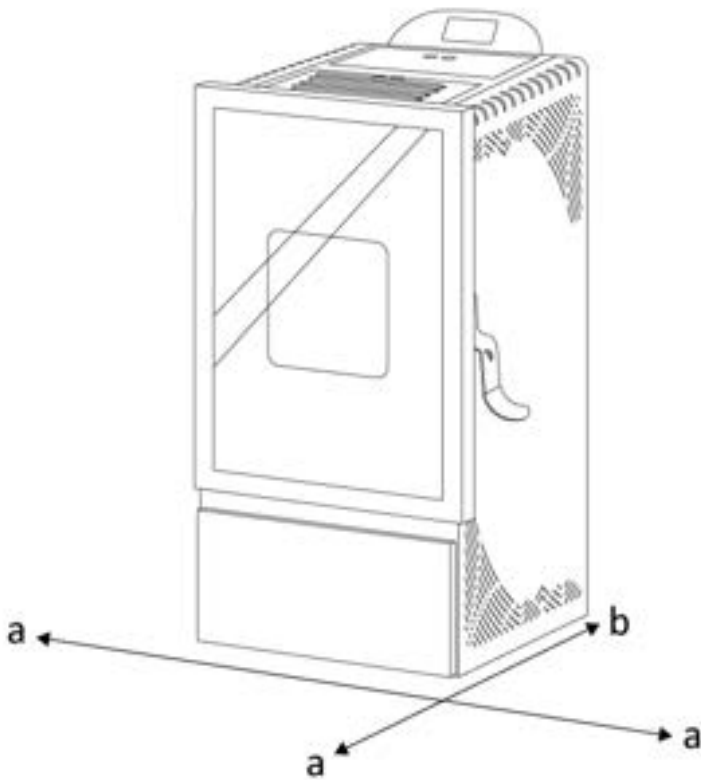

Note

1. To non-combustible objects
 - a) sides > 40 cm, b) back > 25 cm
2. To combustible objects
 - a) sides > 150 cm, b) back > 25 cm

Tip

Please observe a minimum distance of 40 cm behind and sideways the stove for maintenance.

2.5: BEFORE SET UP

Floor bearing capacity

Ensure that the substructure can bear the weight of the stove prior to set-up.

Note

No modifications may be made to the firing installation. This also leads to loss of warranty and guarantee.

Floor protection

A base is recommended (glass, sheet steel or ceramic) if the floor is combustible (wood, carpet, etc.). Please observe the respective local regulations and rules.

Flue pipe connection

Flue pipes pose a source of hazard regarding gas leaks and fire. Get the advice of an authorized specialist company for the layout and assembly.

Please observe the corresponding installation guidelines for walls paneled with wood when connecting your flue pipes to the stove.

Observe the formation of flue gas (atmospheric inversion) and draughts when the weather is unfavorable.

Infed of too little combustion air can lead to smoke in the rooms or to flue gas leaks. Hazardous deposits in the stove and chimney may also occur.

If flue gas escapes, let the fire burn out and check whether all the air intake openings are free and the flue gas pipes and the stove pipe are clean. If in doubt, notify the master chimney sweep since draught malfunctions may be connected to your chimney.

PELLET BOILER STOVE – AMANDA Diva 16,1 kW

2.6: THE CORRECT CHIMNEY CONNECTION

There are several ways to connect your stove to the chimney, ex:

For the selection of the connection and to ensure a proper connection between the stove and chimney, please read the guide 5: Installing the stove or ask your local chimney sweep.

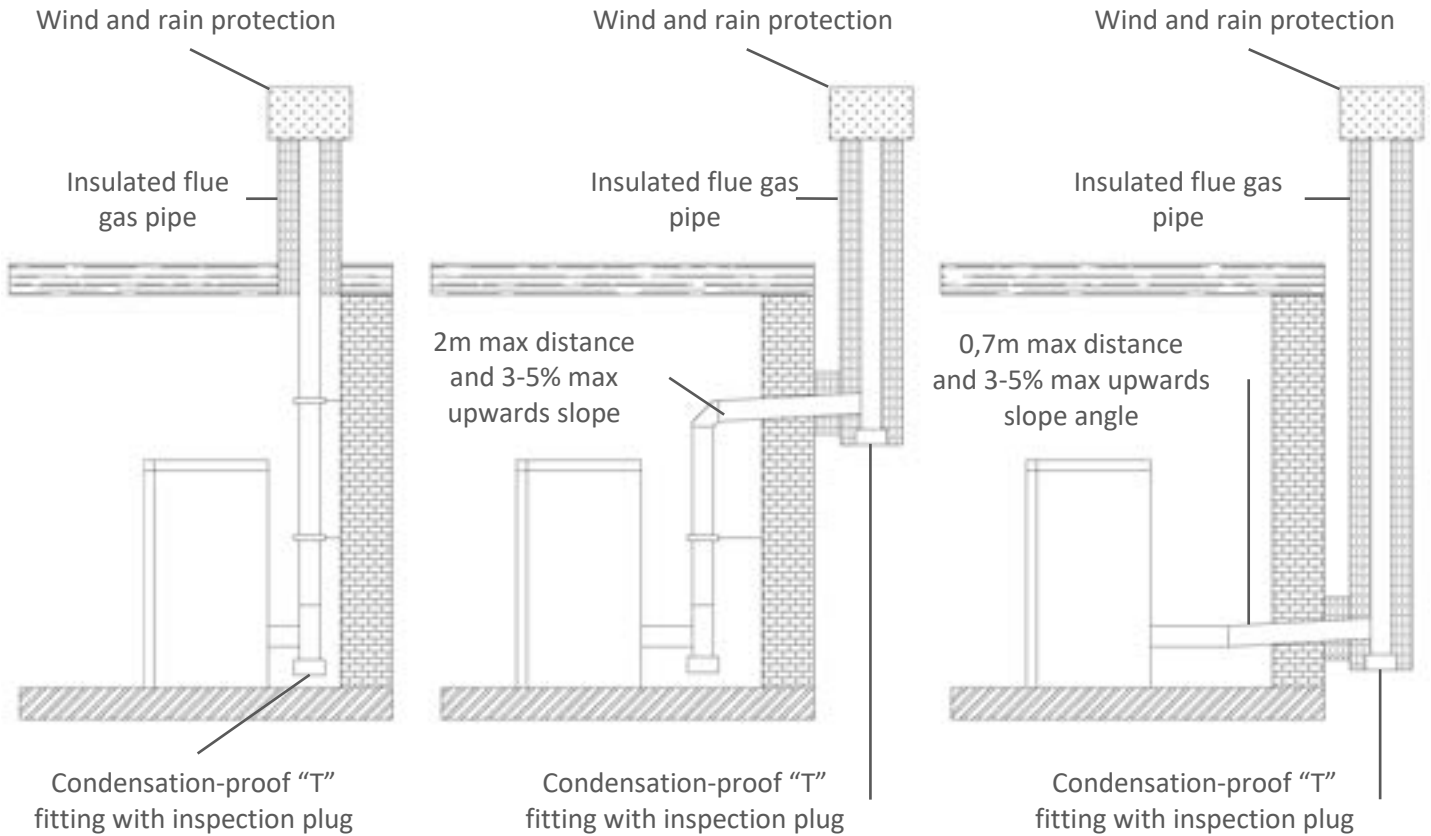

PELLET BOILER STOVE – AMANDA Diva 16,1 kW

3: BRIEF INFORMATION ON PELLETS

3.1: WHAT ARE PELLETS?

Wood pellets are a standardized fuel. Every manufacturer must adhere to certain conditions in order to enable flawless, energy-efficient heating. Pellets are made from wooden waste, from sawmills and planning workshops, as well as from residue from forestry operations. These “starting products” are crushed, dried, and pressed into Pellet “Fuel” without any bonding agent.

ENplus – Pellets

This ENplus standard sets benchmarks in the European pellet market. The traceability of pellets is ensured thanks to the use of identification numbers. The pellet manufacturers’ production facilities and manufacturing processes are reviewed every year. A quality assurance system ensures the pellets comply with the requirements of the new standard and that the conditions for trouble-free heating are guaranteed.



3.2: WOOD PELLET SPECIFICATION ACCORDING TO ENPLUS - A1

Your pellet stove is only approved for the burning of pellets of tested quality.

Please ask your pellet stove dealer for tested fuel and a list of monitored fuel manufacturers.

Note

Only burn pellets that have been inspected according to ENplus-A1. Using poor quality or prohibited pellet fuel will have a negative effect on the function of your pellet stove and can also lead to the warranty becoming null and void, as well as the product liability connected with this.

Note

Burning straw, maize, woodchips etc. is not permitted! Observe waste incineration legislation! Non-observance of these regulations makes void all warranty and guarantee claims and may impair the safety of the unit!

3.3: PELLET HOPPER REFILLING DURING OPERATION

Warning

When filling, avoid direct contact between the plastic bag and the hot stove. Immediately remove all pellets that have fallen on the hot stove or next to the container.

We recommend always having a suitable number of pellets in the container to prevent the fire from extinguishing due to a lack of fuel. Check the level frequently. However, the container lid should be kept closed, except during filling.

3.4: PELLET STORAGE

In order to guarantee problem free burning of the wooden pellets, it is imperative necessary to store the fuel as dry as possible and free from impurities.

Pellets should not be kept in sacks outdoors or stored in a manner where they are exposed to the environment. This can lead to blockages in the screw conveyor.

Note

Blocked pellet feeders are excluded from the warranty.

PELLET BOILER STOVE – AMANDA Diva 16,1 kW

4: TECHNOLOGY & SAFETY FUNCTIONS

The technological advances in your new stove are the result of years of testing and practical experience.

4.1: OPERATING COMFORT

The microprocessor-controlled combustion regulation optimizes the interaction of flue gas blower and screw using the current gas temperature. This guarantees optimum combustion and operating status.

All functions can be regulated centrally using the integrated operating unit. The intuitive graphic interface permits easy operation, all the settings can be made quickly and simply.

4.2: HIGH EFFICIENCY – LOW EMISSIONS

A very great heat exchange surface together with optimum combustion air control leads to excellent fuel utilization.

Fine continuous pellet dosing in an optimized burner pot made of high-quality grey cast iron leads to virtually complete combustion with very good exhaust gas values - and this is guaranteed in every operating phase.

Note

During operation, the flame noise, pellets dropping and actuation of the electronic components are audible due to the automatic control.

4.3: PRESSURE IN THE COMBUSTION CHAMBER

The negative pressure in the combustion chamber is an absolute must. Below a defined threshold, a correct operation cannot be guaranteed, please do perfect sealing of all openings (door, chimneys). Perform checks at all gaskets regularly. (see 13.1: Inspection and maintenance plan)

4.4: EMERGENCY PRESSURE RELIEF VALVE

The emergency pressure relief valve is located on the top of the stove under the upper cover and is only engaged to protect your stove and avoid damage when the pressure in the combustion chamber increases rapidly after an explosion.

There are rare cases where the stove fails to light the fire due to moisture in pellets, dirty chimney, dirty burning pot or bad pellet quality, in that case the stove produces lot of smoke. If the smoke cannot exit the stove freely through the flue gas pipe it will be accumulated in the combustion chamber. This smoke is highly flammable, which means that a spark will potentially ignite it causing a rapid increase in pressure in the combustion chamber and

eventually cause an explosion. In that case, the Emergency Pressure Relief Valve will engage releasing some of the pressure and smoke out of the stove and into the room protecting the glass from breaking and other damages to the stove.

Note

If the valve has engaged do not start the stove again until you call the service center. Maintenance to the valve and other components should be done before starting the stove again.

Note

It is not guaranteed that the Emergency Pressure Relief Valve will prevent any damage to the stove or keep the glass from breaking in case of an explosion. Damages to the stove or house due to an explosion are not covered by warranty.

Note

To prevent this, clean the stove and chimney regularly, following the maintenance schedule instructions and performing all the required cleaning procedures accordingly. Additional precautions include using only high-quality pellets and never storing your pellets outdoors or in high moisture rooms.



4.5: LOW-TEMPERATURE SHUTDOWN

The unit switches off if the stove cools below a minimum temperature. This switch-off may occur if pellet ignition is delayed.

4.6: ELECTRICAL EXCESS CURRENT PROTECTION

The stove has a main fuse to protect against excess current.

4.7: AUTO CLEAN

The speed of the flue gas fan is increased for a short period after every hour to blow ash from the burn pot, increasing the operational safety. The status indicator "CLEAN" appears on the display.

PELLET BOILER STOVE – AMANDA Diva 16,1 kW

4.8: EASY CLEAN

The stove features two Cleaning Levers for easy cleaning of the stove.



Top Cleaning Lever

Used to clean the vertical heat exchanger

4.9: ASH TRAP

This technology helps keep your chimney clean for longer periods of time. The Ash Trap uses centrifugal force to gather ash from the flue gas so that the exhausted smoke is as much ash-free as possible. All the ash gathered from the flue gas is stored in a container at the lower right part of the stove (as you face the stove) and behind the right-side cover (see picture below).



This container should be cleaned at least once every month by following these steps:

- Remove the right-side cover of the stove
- Unscrew the 2 screws holding the cap located near the base of the stove

5: INSTALLING THE STOVE

5.1: GENERAL INFORMATION

The following paragraphs provide instructions that must be complied with in order to ensure maximum efficiency of the product purchased.

The following instructions are however subordinate to compliance with any national, regional and local laws and

- Clean using a vacuum cleaner

Make sure to screw and tighten the cap back in its place, followed by the left side cover, before operating the stove again.

4.10: COMPONENT MONITORING

All the electrical components used are continuously monitored during operation. If a component is defective or can no longer be actuated correctly, then operation is stopped and a warning or error message is issued (see 12: Alarm management).

4.11: FEEDER MOTOR MONITORING

Too long or wet pellets as well as pellets with too high dust content (see 3: Brief information on pellets) can cause so-called “feeder jammers” in the feeder channel. This may also happen if the pellets accumulate in the burn pot and the backlog reaches into the chute. The feeder motor reacts in both cases with an increased current consumption. The stove will be stopped. In this case please call the service center immediately.

4.12: POWER FAILURE (DURING OPERATION)

After a brief power failure, the operating functions that were set before the power failure, continues. If the power failure lasts longer, the stove goes to start phase if enough temperature or embers are present. If the power failure lasts too long, the stove goes into the stop phase. The flue gas fan continues to burn any pellet residues (approximately 8 minutes). Then it will restart automatically.

4.13: POWER FAILURE (DURING IGNITION)

After a brief power failure, the boot process continues. If the power failure lasts longer, the stove is in the stop phase. The flue gas fan continues to burn any pellet residues (approximately 10 minutes). Then it will restart automatically.

Note

Use UPS or other protection against high voltage charge. (Damage caused by power over voltage, voltage spikes or other power related sources is excluded from warranty)

standards in force in the country where the product is installed.

The stove must be installed by qualified personnel in compliance with EN 10683.

5.2: SAFETY PRECAUTIONS

Responsibility for work carried out in the place where the stove is installed lies with the user; the user is also

PELLET BOILER STOVE – AMANDA Diva 16,1 kW

responsible for making sure the installation checks are completed.

The user must abide by all local, national and European safety requirements.

The appliance must be installed on floors with a suitable load-bearing capacity.

The stove assembly and dismantling instructions are reserved exclusively for specialist technicians. Users should always contact our service center to request work to be performed by qualified technicians.

Before having work performed by other technical personnel verify their effective technical competence. Before starting to assemble or dismantle the stove, the installer must heed the safety precautions required by law, specifically:

- Do not work in adverse conditions.
- Always be in a fit mental-physical state for working and make sure that personal protective equipment is in perfectly working order.
- Always wear safety gloves.
- Always wear safety shoes.
- Always use electrically insulated tools.
- Make sure that the area being used for assembly and dismantling is clear of any obstacles.

Note

Assembly may only be performed by authorised specialist companies.

Note

Please observe the regional safety and building regulations. Please contact your master chimney sweep in this context.

Note

Only use heat-resistant sealing materials as well as corresponding sealing strips, heat-resistant silicon and rock wool.

Note

Also take care that the flue does not project into the free cross-section of the chimney.

Note

The stove should not be pushed on unprotected floors.

5.3: CONNECTION TO THE CHIMNEY

- The device must be connected to an approved chimney for solid fuels. The chimney must have a diameter of min. 80mm.

- Avoid long flue pipes to the chimney. The horizontal length of the flue pipe should not exceed 2 m.
- Avoid using too many bends of the flue gas pipes. There should not be more than 3 bends in the exhaust pipe.
- If you just cannot connect directly to the chimney, please use a connection with a cleaning opening.
- Connections must be made of metal and must meet the requirements of the standard (install the connections airtight).
- Before installing, a chimney calculation must be made. The evidence must be performed according to EN 13384-1 and EN 13384-2.
- The maximum draft of the chimney should not exceed 15 Pa.
- The derivation of the flue gases must be guaranteed even during a temporary power outage.

5.4: CONNECTING TO A STEEL CHIMNEY

- The connection must be calculated and shown with EN 13384-1 and EN 13384-2.
- Use only insulated (double) stainless steel tubes (flexible aluminum or steel tubes are not permitted).
- An inspection door for regular inspection and cleaning must be present.
- The flue pipe connection to the chimney must be airtight.

PELLET BOILER STOVE – AMANDA Diva 16,1 kW

5.5: STOVE INSTALLATION SITE

The paragraph 2.4: Safety distances shows the minimum clearances from combustible materials and objects that must be observed when positioning the stove.

Protect all structures that may catch fire if exposed to excessive heat.

Floors made from flammable materials such as: wood, parquet, linoleum, laminates or carpets **must be protected by a suitably-sized fireproof base** underneath stove. Such base may be made from steel, slate, glass or stone and must cover **the floor in the part underneath the stove and the flue attachment, and must extend at least 50 cm at the front.**

The manufacturer declines all liability for any alterations to the characteristics of the material **making up the floor underneath the protective base.**

Any elements made from wood (e.g. beams) or other combustible material located near the stove **should be protected with fireproof material.**

Flammable walls or elements must be kept at least 150 cm away from the stove.

Leave enough clearance for maintenance work.

Note

If connecting to multiple connection chimneys additional safety equipment is required. Your local chimney sweep will advise you in this case.

Note

Be sure to prevent condensed water from entering via the flue connection. You may need to have a condensate ring installed - ask your chimney sweeping expert for more information. Damages caused by condensate are excluded from manufacturer's warranty.

5.6: FEEDING IN EXTERNAL COMBUSTION AIR

- Combustion air must be fed to the stove from outside via a sealed pipe for operation independent of the room air, it must be possible to shut off the combustion air pipe.
- The open/closed setting must be clearly recognizable.
- Connect a pipe Ø54mm at the air intake and fix it with a hose clamp (not included). For configurations with pipes over 4m, use Ø100mm pipes.
- To ensure enough air intake, the intake pipe should not exceed max. 1m and have max. 3 bends.
- In extreme cold pay attention to icing on the air intake opening (check).

- It is also possible to suction in combustion air directly from another sufficiently vented room (e.g. cellar).
- The combustion air pipe must be tightly connected permanently to the air nozzles of the stove.
- If you do not use the stove for a long time, please close the combustion air intake to prevent the stove from moisture.

If one or more of these conditions does NOT apply, the result is poor combustion in the stove and negative pressure in the installation room.

5.7: FLUE GAS EXHAUST

The stove operates with negative pressure in the combustion chamber, and consequently the flue gas discharge must be airtight.

The stove must be connected to its own separate flue gas exhaust system capable of ensuring adequate atmospheric dispersion of the combustion byproducts.

The components making up the flue gas exhaust system must be suitable for the specific operating conditions and bear the CE mark.

Note

An initial vertical section measuring a minimum of 1.5 meters is required to ensure correct flue gas exhaust.

Note

It is necessary to connect a pipe at the bottom of the "T" junction in order to discharge the smoke condensate that could form in the flue gas exhaust (see 2.6) The correct chimney connection).

Anchor the flue pipes to the wall using special collars.

The flue gas exhaust attachment **MUST NOT BE** connected to:

- A chimney used by other heat generators (boilers, stoves, fireplaces, etc.)
- Air exhaust systems (range hoods, vents, etc.)

Chimney pipe dampers should be easily accessible.

5.8: DISCHARGED THROUGH ROOF USING A TRADITIONAL CHIMNEY

The chimney used to discharge the flue gas must be made in accordance with standards UNI 10683 – EN 1856-1-2 – EN 1857 – EN 2553 – EN 13384-1-3 – EN 12391-1 both as regards the dimensions and the construction materials used.

DAMAGED chimneys made from unsuitable material (asbestos cement, galvanized steel, etc. with rough and porous inside surface) are prohibited by law and affect proper stove operation.

PELLET BOILER STOVE – AMANDA Diva 16,1 kW

The flue gas can be discharged through a traditional fire place chimney as long as you make sure on the state of maintenance of the chimney.

Note

For larger chimneys suitably insulated steel pipes need to be inserted on the inside (diameter according to the length).

Make sure connections to brick chimneys are suitably sealed.

Note

If the flues run through wooden roofs or walls, special certified pass-through kits need to be used, available on the market.

5.9: LEVELLING THE STOVE

The stove must be levelled by adjusting the feet, then checked using a spirit level.

5.10: SYSTEM CONNECTIONS

5.10.1: ELECTRICAL CONNECTION

The stove is connected to the electrical system simply using the plug supplied. The electrical connection (plug) must be easily accessible when the stove is installed.

Note

If the power cord is damaged it must be replaced by technical service or a qualified technician, to prevent any kind of risk.

The system must be earthed and fitted with a residual current circuit-breaker in accordance with legislation in force

Note

The flue must have its own earth connection.

5.10.2: INSTALLING THE AMBIENT ROOM THERMOSTAT

The stove is equipped with a room thermostat (cable) located at the back of the stove, untie the cable and place the thermostat at the correct height and distance from the stove in order to get proper and accurate measurements. Do not place the stove and thermostat in tight places since the values of the thermostat will not be correct.

Improper installation of the thermostat will cause problems in combustion, heating and maintenance of the stove.

Warning

It is important to place the room thermostat at the correct height and distance from the stove as its value defines the pellet consumption of the stove. Use a wall thermometer at the other side of the house during operation and compare the accuracy of the stove's thermostat, changing its mounting place until you got almost the same measurement at the stove's screen and wall thermometer.

PELLET BOILER STOVE – AMANDA Diva 16,1 kW

5.1 1: POST-INSTALLATION WORK

When the installation is finished, boiler ventilation should be performed. The automatic ventilator is on the right side of the appliance. Open the side cover and unscrew the valve on the top, until the trapped air in the boiler is fully removed. Then, screw the valve and close the side cover. Repeat the process when the appliance is out of use for a long period of time. See picture.



The appliance functions with an external thermostat which is activated in case of water overheating and cuts the power supply, in order to turn the appliance off.

Manual deactivation: unscrew the protective cover and, with the use of a screwdriver, press the safety button to reset it. See pictures to the right.



PELLET BOILER STOVE – AMANDA Diva 16,1 kW

5.1 1.1: TYPICAL HYDRAULIC DIAGRAM:

The hydraulic diagram is used as an example and not as installation plan.

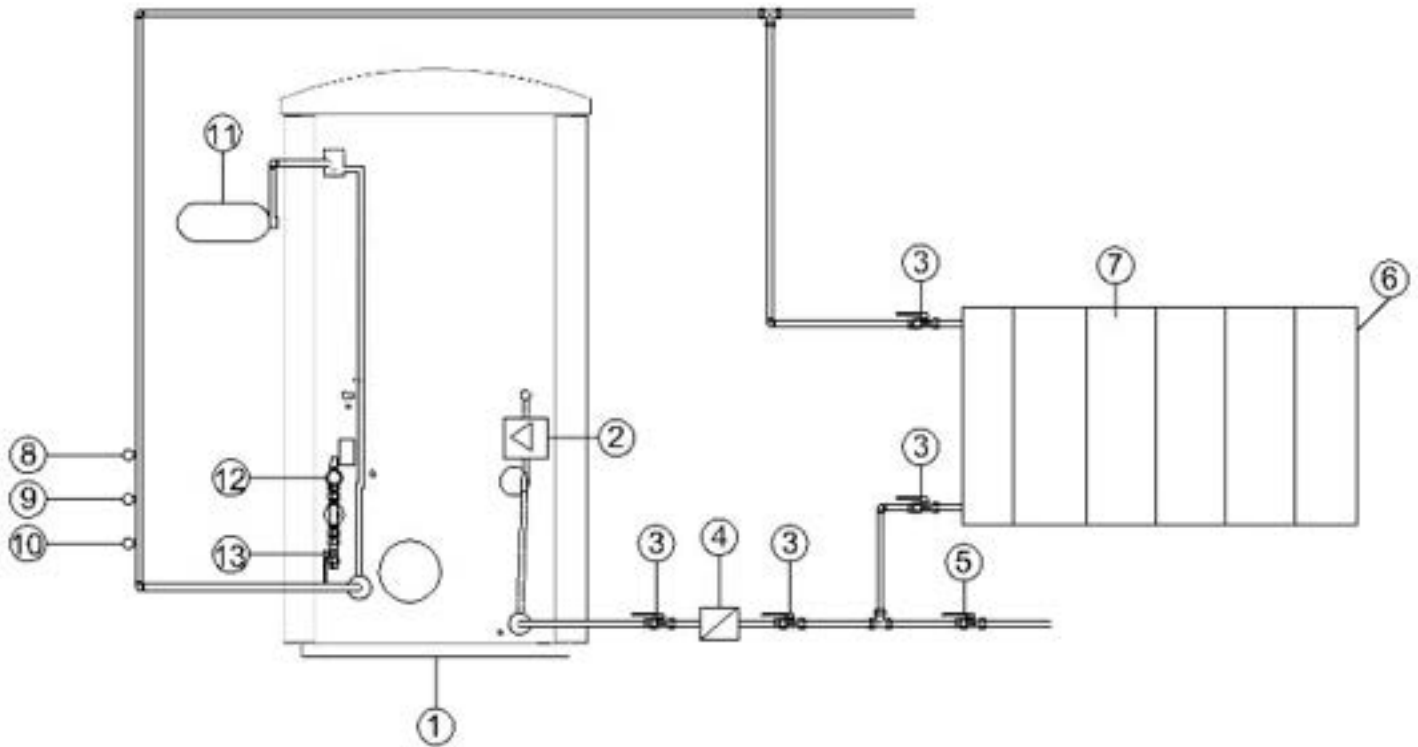

- 1) Device
- 2) Circulator
- 3) Valve
- 4) Filter
- 5) Finishing valve
- 6) Radiator vent
- 7) Radiator body
- 8) Circulator thermostat
- 9) Thermometer
- 10) Manometer
- 11) Closed expansion tank
- 12) 3 bar safety valve
- 13) Pressure relief valve



Connection of pressure relief valve and 3 bar safety valve.

PELLET BOILER STOVE – AMANDA Diva 16,1 kW

6: CONTROL PANEL

6.1: DESCRIPTION

The control panel consists of:

- A LED array on the top part of the controller with status LEDs and current menu indicators.
- A Display.
- An On/Off button
- A Cancel button
- Two Menu buttons to scroll between the various menus.
- Two Edit buttons to modify the different values and parameters and access the submenus.
- An Enter button

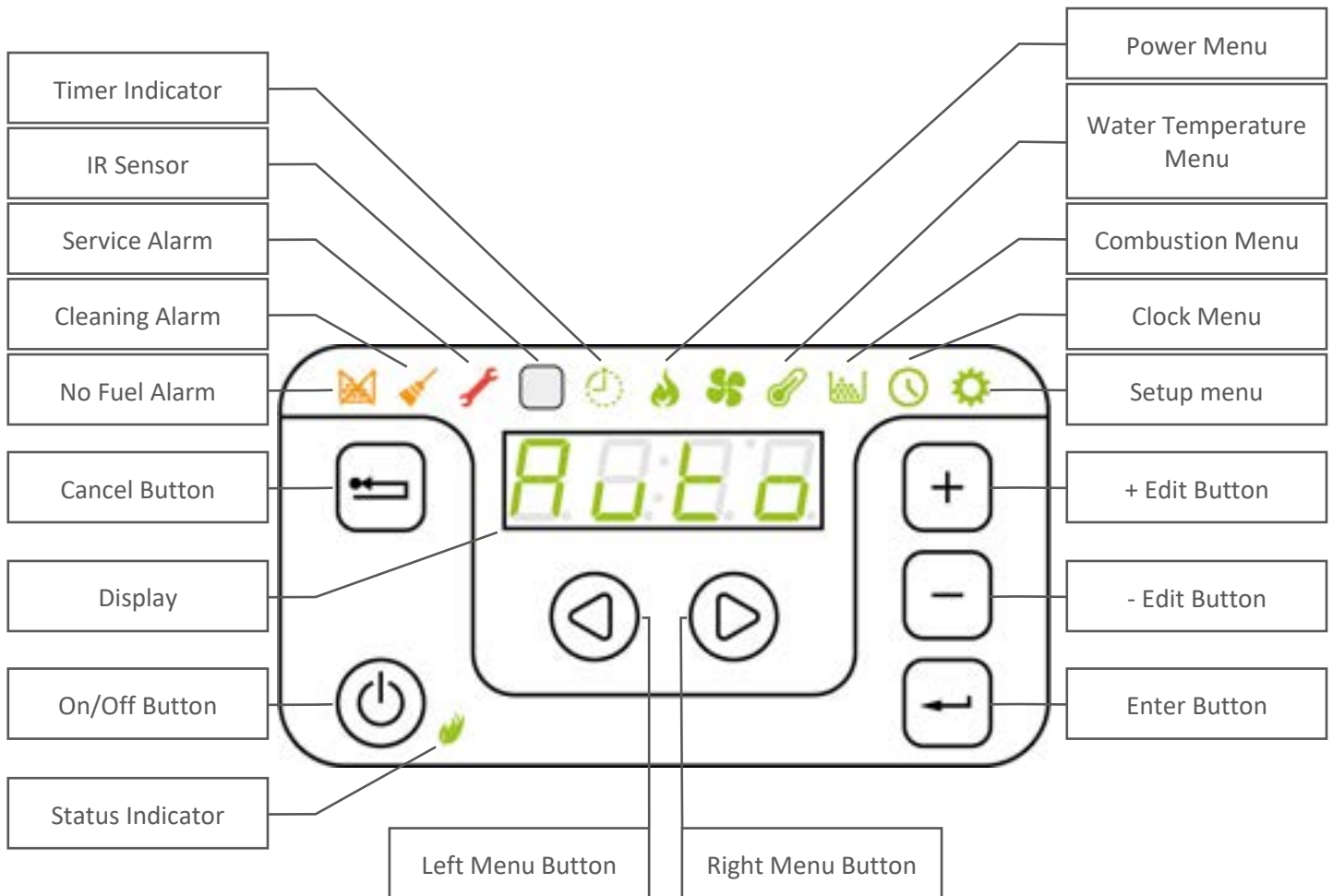

Note
All the buttons are capacitive, which means you only need to firmly touch the buttons to use them.

PELLET BOILER STOVE – AMANDA Diva 16,1 kW

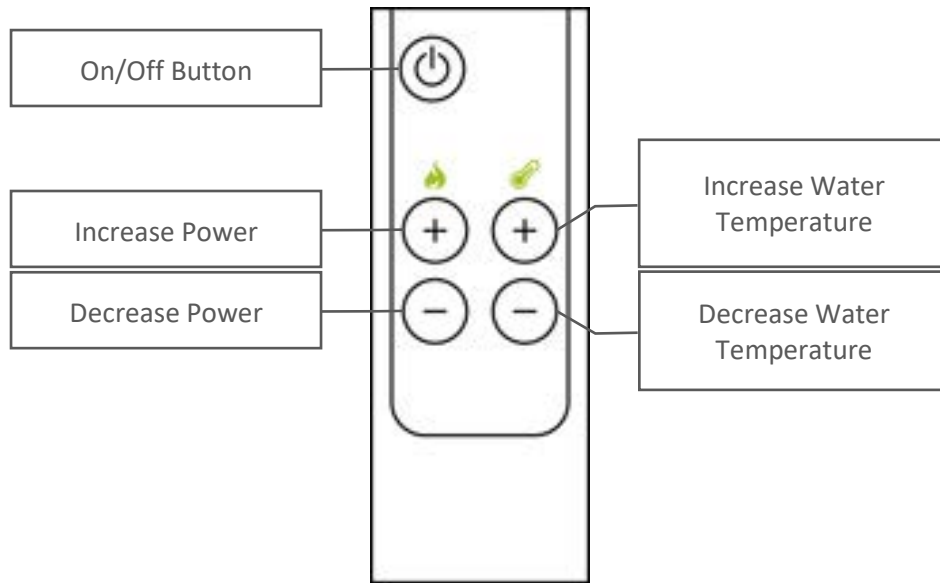

The IR remote controller allows you to change certain basic functions without having to reach for the stove.

6.2: USING THE CONTROL PANEL







- The Menu buttons are used to scroll between the different menus that are highlighted.
- When selecting a given function, simply press the Enter button and then modify the values using the Edit buttons .
- Pressing the Enter button confirms the setting.
- In general, all values that are blinking can be modified using the Edit buttons .
- The Cancel button is used to cancel any changes; **pressing and holding the button displays any active alarm or error codes.**

6.3: STATUS LEDS

Icon	Indication	Description
	No Fuel	Indicates that the pellet hopper needs to be refilled.
	Cleaning	Indicates the need to perform maintenance.
	Service	Indicates an error.
	Remote control receiver	It receives the inputs sent by the remote control (optional).
	Timer	Indicates whether the Weekly Schedule is active.
	Status	LED on steady: stove on and operating LED flashing: stove in the ignition stage or in standby LED off: stove off

PELLET BOILER STOVE – AMANDA Diva 16,1 kW

6.4: CONTROL PANEL MENUS

Icon	Menu	Submenu	Description	Values
	Power	[1] Stove power	Stove output setting. (Suggested Auto)	1 to 4 Auto
	Temperature	[1] Water temperature	Displays the room temperature reading and is used to set the desired temperature.	Up to 80°C (συστήνεται <68°C)
	Combustion	[1] Pellet combustion	Amount of oxygen provided to fire (Same amount of pellet)	1 to 3
	Clock	[1] Time / date	Time and date settings	
		[2] Weekly timer	Enables or disables the timer. The  icon will light if set to “ON”.	OFF ON
		[3] Weekly timer programs	Set the start, end and temperature settings for each program. (Max 6 programs)	[P1] to [P6]
		[4] Weekly timer days	Assigns programs to the different days of the week. (Max 3 programs per day)	[d1] to [d7]
	Setup	[1] Key lock	Disables the buttons on the keypad	OFF Lo Hi
		[2] Idle display brightness	Sets the idle display brightness	OFF 1 to 5
		[3] Idle display mode	Sets the preferred display mode	OFF 1 to 3
		[4] Beeper volume	Sets the beeper volume	OFF 1 to 5
		[5] Temperature unit	Sets the preferred temperature unit	°C °F
		[6] Software version	Displays the controller software version	
		[7] Manual feed	Refills the combustion pot	
		[8] Hours remaining	Displays the number of operating hours remaining until recommended maintenance. Starts at 970h after every service.	
		[9] Service menu	Reserved for the service center. Authorized personnel only.	

PELLET BOILER STOVE – AMANDA Diva 16,1 kW

7: PRELIMINARY CONTROL PANEL OPERATIONS

7.1: LOADING THE PELLETS

The first operation to be performed before starting the appliance is to fill the hopper with fuel (pellets). The pellets are loaded into in the hopper using a scoop (not included).

Do not empty the sack directly into the hopper to avoid loading sawdust or other foreign bodies that may affect proper stove operation and avoid spilling pellets outside of the hopper.

Make sure the hopper lid is well closed again after having loaded the pellets.

Plug the stove into the mains power supply, move the power switch at the rear of the stove to the “ON” position. If the connections are correct the stove will emit a series of intermittent beeps, the display will come on.

Note

If not using the appliance for an extended period, the switch at the rear of the stove should be moved to the “OFF” position.

























Note

Use UPS or other protection against high voltage charge. (Damage caused by power over voltage, voltage spikes or other power related sources is excluded from warranty)

8: INITIAL SETTINGS









8.1: TIME AND DATE SETTINGS

To set the time, date, year and weekday:

- a) Use the   buttons to go to the Clock menu 
- b) Use the   buttons to scroll to and select submenu **[1]** and press  to confirm
- c) The hour value will start blinking, use the   buttons to modify the value and press 
- d) The minutes value will start blinking, use the   buttons to modify the value and press 
- e) The day value will start blinking, use the   buttons to modify the value and press 
- f) The month value will start blinking, use the   buttons to modify the value and press 
- g) The year value will start blinking, use the   buttons to modify the value and press 
- h) The weekday value will start blinking (1 = Monday to 7 = Sunday), use the   buttons to modify the value
- i) Press  to confirm the settings.









8.2: SETTING THE DISPLAY BRIGHTNESS

This value determines the brightness of the display when the display is in idle mode.

- a) Use the   buttons to go to the Setup menu 
- b) Use the   buttons to scroll to and select submenu **[2]** and press  to confirm
- c) The brightness value will start blinking, use the   buttons to set one of the following values:
 - “OFF”
 - “1” minimum to “5” maximum
- d) Press  to confirm the settings.

PELLET BOILER STOVE – AMANDA Diva 16,1 kW







8.3: SETTING THE BEEPER VOLUME

- a) Use the   buttons to go to the Setup menu 
- b) Use the   buttons to scroll to and select submenu **[4]** and press  to confirm
- c) The volume value will start blinking, use the   buttons to set one of the following values:
 - “OFF”
 - “1” minimum to “5” maximum
- d) Press  to confirm the settings.

8.4: IMPROVING THE COMBUSTION

A good combustion depends on several factors (type of installation, operation and maintenance conditions, type of pellet etc.)

If the brazier contains a lot of waste at the end of combustion, it is advised to change the combustion configurations (increasing the value) to find the most satisfactory solution.

- a) Use the   buttons to go to the Combustion menu  and press 
- b) Use the   buttons to set one of the following values:
 - **“1” Standard combustion air supply**
 - **“2” 10% more combustion air supply than “1”**
 - **“3” 5% more combustion air supply than “2”**
- c) Press  to confirm the settings.

Note

The above process does not affect fuel consumption.

PELLET BOILER STOVE – AMANDA Diva 16,1 kW

9: STOVE OPERATION







9.1: OPERATING PARAMETERS

Stove operation is determined by the Power level, Fan and Temperature parameters set by the user.

9.1.1: SETTING THE POWER LEVEL

The power level defines the amount of heat produced by the stove and consequently directly affects fuel consumption.

To change the power level:

- a) Use the   buttons to go to the Power menu  and press 
- b) The power level value will start blinking, use the   buttons to set one of the following values:
 - “1” minimum to “4” maximum
 - “Auto” = automatic functioning (the stove will set the fan speed and the power automatically according to the room temperature, and the desired water temperature)
- c) Press  to confirm the settings.

Tip

Using the **Auto** value gets the desired temperature at less time and also consumes less fuel.

9.1.2: SETTING THE ROOM TEMPERATURE

Setting this value defines the desired room temperature, read directly by a probe fitted on the stove.

To set the desired temperature:

- Use the provided settings from the room thermostat that you chose.
- The device operates according to the desired temperature of the room thermostat and the desired water temperature.
- When one of the desired temperatures is reached, the stove will shut down.
- In relation to the water temperature the stove shuts down at +2°C above the desired and turns on again at -2°C of desired.
- In relation to the room temperature, the setting comes directly from the room thermostat. If the room thermostat is digital it allows for differential setting, if it's analog the stove shuts down at the desired temperature and turns on again at -2°C of desired.

Warning

It is important to place the room thermostat at the correct height and distance from the stove as its value defines the pellet consumption of the stove. Use a wall thermometer at the other side of the house during operation and compare the accuracy of the stove's thermostat, changing its mounting place until you got almost the same measurement at the stove's screen and wall thermometer.

9.2: SWITCHING THE STOVE ON

Warning

Before every ignition, be sure that the burning pot is completely empty and properly positioned in its seat.

To start the stove, hold the  button for several seconds.

The leaf icon will start flashing during the ignition stage until remaining on steady when the stove has started.

Tip

Automatic stove ignition: The stove comes with an automatic device that starts the pellet stove without using any traditional fire lighters.

Note

Avoid lighting the flame manually if the stove's automatic ignition system is not working correctly.

PELLET BOILER STOVE – AMANDA Diva 16,1 kW

9.3: MODIFYING THE PARAMETERS (SEE 8.4: IMPROVING THE COMBUSTION)

The stove operating parameters can be modified as described.

The values set will be retained until next modified, even when the stove is switched off or unplugged from the power supply.

9.4: SWITCHING THE STOVE OFF

To switch off the stove hold the  button for several seconds; the leaf icon will switch off.

Note

To start the stove again it's recommended to wait for the stove to cool down completely.

9.5: OPERATING BY MONITORING ROOM TEMPERATURE

The stove can be switched on/off manually or in programmed mode.

- In relation to the water temperature the stove shuts down at +2°C above the desired and turns on again at -2°C of desired.
- In relation to the room temperature, the setting comes directly from the room thermostat. If the room thermostat is digital it allows for differential setting, if it's analog the stove shuts down at the desired temperature and turns on again at -2°C of desired.

9.6: RESTARTING AFTER A POWER FAILURE

In the event of power failures, the stove will switch back on automatically, checking the safety conditions, when power returns. See 4.11: Feeder motor monitoring., 4.12: Power failure (during heating) and 4.13: Power failure (during the initial stage).

PELLET BOILER STOVE – AMANDA Diva 16,1 kW

10: WEEKLY SCHEDULE

10.1: WEEKLY TIMER

It's possible to set, enable and assign, to each day of the week, customized programs to automatically switch the stove on and off.

























The days of the week are identified by numbers: Monday = "d1" to Sunday = "d7".

You can set up to 6 programs that direct the stove's on/off times and the temperature to operate at during those times and you can assign up to 3 programs per week day.

Note













The stove always follows the directions given from the room thermostat, in order for the weekly schedule to operate correctly, the room thermostat must be set to a desired temperature.

10.2: SETTING THE WEEKLY TIMER PROGRAMS









- Use the   buttons to go to the Clock menu 
- Use the   buttons to scroll to and select submenu **[2]** and press  to confirm
- Use the   buttons to scroll to and select a program: "P1" to "P6"
- The on hour value will start blinking, use the   buttons to modify the value and press 
- The on minute value will start blinking, use the   buttons to modify the value and press 
- The off hour value will start blinking, use the   buttons to modify the value and press 
- The off minute value will start blinking, use the   buttons to modify the value and press 
- The desired temperature value will start blinking, use the   buttons to modify the value and press 
- Press  to confirm the settings

10.3: ASSIGNING THE WEEKLY TIMER PROGRAMS TO SPECIFIC DAYS

This function can be used to assign up to three different programs to a certain day.

- Use the   buttons to go to the Clock menu 
- Use the   buttons to scroll to and select submenu **[4]** and press  to confirm
- Use the   buttons to choose the day [d1] to [d7] to assign programs to and press  to confirm
- The value of the first program to assign will start blinking, use the   buttons to set one of the following values:
 - "P1" minimum to "P6" maximum
 - "OFF" to disable
- Press  to repeat step d) to assign more programs, up to the max of 3 programs per day **OR**
- Press  at any time to finish assigning programs and confirm the settings

10.4: ENABLING/DISABLING THE WEEKLY TIMER

- Use the arrow buttons   to go to the Clock menu 
- Use the   buttons to scroll and select submenu **[2]** and confirm by pressing 
- Use the   buttons to set one of the following values:
 - "ON" to enable the timer
 - "OFF" to disable the timer
- Press  to confirm the settings

When the timer is enabled, the  icon will be on steady, indicating that the timer is active.

PELLET BOILER STOVE – AMANDA Diva 16,1 kW

Example

You can disable the Weekly Timer programs in the time of vacations.

The following is an example of a set of 6 programs and their timeline:

[P1]Program 1		[P2]Program 2		[P3]Program 3		[P4]Program 4		[P5]Program 5		[P6]Program 6														
ON	OFF	ON	OFF	ON	OFF	ON	OFF	ON	OFF	ON	OFF													
5:00	7:00	8:00	11:00	12:00	23:00	17:00	23:00	20:00	22:00	4:00	7:00													
16°C		18°C		19°C		18°C		17°C		15°C														
DAY/HOUR	0	1	2	3	4	5	6	7	8	9	10	11	12	13	14	15	16	17	18	19	20	21	22	23
(d1) Mon						16°C														18°C				
(d2) Tue						16°C														18°C				
(d3) Wed						16°C														18°C				
(d4) Thu						16°C														18°C				
(d5) Fri						16°C														18°C				
(d6) Sat						15°C				18°C											17°C			
(d7) Sun						15°C				18°C										19°C				

1 1: MISCELLANEOUS SETTINGS

1 1.1: ENABLING KEY LOCK FUNCTION

This function is used to disable the use of the control panel and avoid accidental modifications.

To enable/disable the function:



- Use the arrow buttons to go to the Setup menu
- Use the buttons to scroll and select submenu **[1]** and confirm by pressing
- Use the buttons to set one of the following values:
 - “Off” Lock keypad disabled
 - “Lo” Only the On/Off button is enabled
 - “Hi” Lock keypad enabled
- Press to confirm the settings

1 1.2: CHANGING THE TEMPERATURE UNITS

- Use the arrow buttons to go to the Setup menu
- Use the buttons to scroll and select submenu **[5]** and confirm by pressing
- Use the buttons to set one of the following values:
 - “C°”
 - “F°”
- Press to confirm the settings

PELLET BOILER STOVE – AMANDA Diva 16,1 kW

12: ALARM MANAGEMENT

If a malfunction occurs, you will hear an audible alarm, followed by one of the following system LEDs   . If the problem concerns an error, the stove will switch off.

Pressing and holding the “cancel” button  shows the error code on the display:

Warning / Error code	Description	Causes	Indicators
A001	Low fuel	Warning fuel level, refuel the tank.	
A002	Maintenance	Time to service expired. **	 *  *
A003	Cleaning	Flue gasses temperature warning level. Chimney, fire pot, or heat exchanger cleaning required.	 *
A004	Low battery	Low battery. **	 *
A005	Speed sensor	Speed sensor failure. **	 *
E002	IR communication error	Infrared sensor malfunctioned. **	
E004	MB communication error	Cable connecting motherboard to screen disconnected or malfunctioned.	
E101	Fire error	Error, caused by, 1. Ignition failed, 2. Pellet quality, 3. No pellets	
---	Chimney dirty	Error, caused by, 1. Chimney, 2. Air intake tube or burning pot dirty, 3. Manually stopped device before flame detection. Clean the stove and restart	 *
E108	Security switch error	Security switch engaged. Let the stove cool down, clean it and try again, if the error persists call service.	
E110	Ambient room sensor error	Ambient room sensor malfunctioned or disconnected. **	
E111	Flue gas temperature sensor	Flue gas temperature thermostat malfunctioned or disconnected. **	
E113	Gas overtemperature	Extremely high flue gas temperature. Chimney or heat exchanger cleaning required.	
----	No pellets	Fuel Ignition timeout expired (empty the burning pot and restart the device) or fuel tank empty (refuel the tank).	

*Blinking

**Call service center

After having checked the type of message, the alarm can be reset by pressing the On/Off button  for a few moments.

Before proceeding with a new ignition, check that:

- The stove has cooled
- The burning pot is clean and free of any ash residue or pellet
- The burning pot is correctly positioned in its seat
- The doors of the hearth and the tank are perfectly closed

PELLET BOILER STOVE – AMANDA Diva 16,1 kW

13: CLEANING AND MAINTENANCE

Only work on the unit when the main plug has been disconnected and the stove has cooled down completely.

During assembly / dismantling do not allow objects (screws etc.) to fall into the pellet hopper – they can block the screw conveyor and damage the stove.

During any work on the stove, take particular care of your fingers and any panels and stove attachments. Select soft bases to prevent scratches to your living space furniture and stove panels.

Your stove must be switched off and cooled before any maintenance work is performed.

Tip

Wood as fertiliser - The mineral content of the wood remains in the combustion chamber as ash as a residue of the combustion. This is an excellent fertilizer for all plants in the garden, it is a completely natural product. The ash should be stored first and extinguished with water.

Note

Ash may contain embers – only place ash in sheet steel containers.

Warning

Ensure that you do not vacuum into the combustion airline during heating operation during any cleaning (vacuuming). You could vacuum out embers – FIRE RISK!

13.1: INSPECTION AND MAINTENANCE PLAN

	Whenever started	7 days	1 month	1 year
Burn pot	X			
Ash bin/Compartment	X			
Glass		X		
Fan Grid			X	
Heat Exchanger (see 4.8:Easy Clean)		X		X
Ignition heater socket			X	
Flue gas pipes			X	
Door and burn pot gaskets				X
General service				X
Ash Trap (see 4.9:Ash Trap)			X	
Horizontal vermiculite at the top of the combustion chamber			X	
Fan				X
Emergency Pressure Relief Valve	If engaged			X

The frequency at which the stove requires cleaning and the maintenance intervals depend on the fuel you use. High moisture content, ash, dust and chips may even double the maintenance required. As mentioned before, it is required that only tested and recommended pellets may be used as fuel.

PELLET BOILER STOVE – AMANDA Diva 16,1 kW

1 4: PROBLEMS – POSSIBLE SOLUTIONS

1 4.1: PROBLEM 1

Fire burns with weak, orange flame. Pellets heap up in fire trough, window getting black.

Cause(s)

- Insufficient combustion air
- Poor chimney draught
- Stove has a lot of soot inside

Possible solutions

- Remove any ash or clinker from the fire trough that may block the air inlets.
- If possible, swap to better pellet quality.
- Check whether flue gas pipes are blocked with ash.
- Check whether the air intake or flue tubes are blocked.
- Check door and cleaning cover seals for leaks.
- Clean fan and the chamber below the fan.
- Have service performed by authorised specialist company.
- Use cleaning levers (see 4.8: Cleaning Levers).
- The window has to be cleaned from time to time.

Warning

Blurred and dark colored glass is always a clue of poor combustion, it is important to solve the problem before using the stove again.

1 4.2: PROBLEM 2

Stove smells strongly and smokes outside.

Cause(s)

- Burning-in phase (service).
- Stove has accumulated dust and/or dirt.

Possible solutions

- Vacuum off any dust deposits from the convection air openings at regular intervals.

Note

Please note that checks on the control system and wiring may only be performed in unit switched dead. Any repairs may only be performed by trained specialists.

Tip

If a malfunction message occurs, the cause must first be remedied; the unit can be put back into operation by acknowledging the malfunction at the internal unit.

1 4.3: PROBLEM 3

The stove emits strong sounds during the operation of the pump.

Cause(s)

- **Air in the water pipes**

Possible solutions

- **Perform degasification work**

PELLET BOILER STOVE – AMANDA Diva 16,1 kW**15: WARRANTY**

Your new heater is accompanied by a two-year warranty, which is substantiated with the receipt or the invoice of payment, and it is valid for your heater if the following statements are true:

- It has not undergone any modification or permanent impairment.
- The stove uses only original spare parts and parts made specifically for this model.
- The installation and operation of the heater is carried out according to the given instructions.
- Protection from overheating.
- Regular maintenance / cleaning (yearly).
- The heater is used, only, by individuals who have enough abilities and proper training.

Additionally, the following must be provided:

- Tax receipt showing the purchase date.
- Installation protocol filled and signed by the installer. (see 16: Installation Protocol)

The warranty is NOT valid, when the appliance has been misused, due to incorrect operation by the user, non-professional modifications and/or repairs, or because of the use of unauthentic or improper replacements for this heater.

The incompliance to the instructions given in this manual entail immediate cancellation of the warranty.

From the warranty are, also excluded parts of the appliance that have undergone impairment, such as glass rope, firebricks and glass.

This document has confidential character and any kind of reproduction is strictly forbidden.

PELLET BOILER STOVE – AMANDA Diva 16,1 kW

16: INSTALLATION PROTOCOL

Installation protocol filled and signed at the day of the installation of the stove

Date:

Installation address	Dealer
Name:	Name:
Street:	Street:
City:	City:
Telephone:	Telephone:

Stove data

Stove type:	Casing undamaged	
Serial number:	Operating instructions	
Warranty documents		

Electrical periphery

Connection socket earthed		Functions checked	
---------------------------	--	-------------------	--

Check of system component

Combustion chamber door seal checked			
--------------------------------------	--	--	--

Exhaust line / chimney

Diameter		Connection leakproof	
Total vertical part length (m)		Chimney draught	
Total horizontal part length (m)			
Number of bends(corners)			

Hydraulic system

Total amount of calories		Installation type (open/closed)	
--------------------------	--	---------------------------------	--



Work performed correctly according to order placed

Technician

Operator

Plumber

Client

Company:



PELLET BOILER STOVE – AMANDA Diva 16,1 kW

17: DECOMMISSIONING AND DISPOSAL

Decommissioning and disposal of the stove are exclusive responsibilities of the owner, who must act in accordance with the laws in force in the country where the stove is installed with regards to safety and environmental protection.

The stove may also be dismantled and disposed of by companies authorized to recover and dispose of the materials in question.

Note

Always observe the standards in force in the country where the stove is decommissioned as regards disposal of the materials and the waste disposal report where required.

Important

All dismantling operations for decommissioning the stove must be performed when the stove is off and disconnected from the power supply.

- Remove all electrical equipment
- Separate the batteries fitted on the electronic boards
- Have the structure of the stove scrapped by an authorized company

Important

Dumping the stove in accessible areas represents a serious hazard to people and animals. Liability for any harm cause to people or animals always lies with the owner. When decommissioning the stove, the CE mark, this manual and other documents relating to this stove must be destroyed.

*Based on **Article 13 by Legislative Decree n°151 of 25th July 2005 actuation of the European Directive 2002/96/CE of 23rd February 2003** on waste electrical and electronic equipment. It is connected to the policy and action which aim to the prevention of waste electrical and electronic equipment, named RAEE, and in addition, the reuse, recycling and other forms of recovery of such wastes to reduce the disposal of waste. It also seeks to improve the environmental performance of all operators involved in the life cycle of electrical and electronic equipment.*

PELLET BOILER STOVE – AMANDA Diva 16,1 kW

18: PRODUCT FICHE

Product fiche						
	Unit	Pellet Burning Stoves				
Model		AMANDA diva	AMANDA plus	AMANDA standard	Evita	
Energy efficiency class		A+	A+	A+	A+	
Direct heat output	kW	1,4	12,8	9,1	6,1	
Indirect heat output	kW	14,7				
Energy efficiency index		128,3	128,9	126,7	125,6	
Useful energy efficiency						
At nominal heat output	%	90,8	91,5	90,3	90,5	
At minimum heat output	%	92,6	92,5	91,2	91,2	
	Unit	Wood Burning Boiler Stoves				
Model		DG 2300	DG 2200	DG 2100	DG 2000	
Energy efficiency class		A	A	A	A	
Direct heat output	kW	8,4	6	5,8	3,9	
Indirect heat output	kW	20,2	16	13,8	11,1	
Energy efficiency index		101,1	97	95,7	97,3	
Useful energy efficiency						
At nominal heat output	%	76,6	73,8	82,9	74	
	Unit	Wood Burning Stoves				
Model		SG 1200	SG 1100	MG 600	MG 500	
Energy efficiency class		A+	A	A+	A	
Direct heat output	kW	16,4	12	16	22	
Energy efficiency index		107,7	91,5	108	103,1	
Useful energy efficiency						
At nominal heat output	%	81,2	70	81,4	78	
	Unit	Wood Burning Stoves				
Model		MG 450	MG 400	MG 300	MG 250	MG 100
Energy efficiency class		A	A	A	A+	A
Direct heat output	kW	14,8	15,3	15	11,3	8,5
Energy efficiency index		106	100,2	97,2	107,7	100,9
Useful energy efficiency						
At nominal heat output	%	80	76	73,8	81,2	76,5

